



FIXNORDIC.DK

UniVent Fra FIXNORDIC



DATABLAD

UniVent
Fra Fixnordic

PRODUKT BESKRIVELSE

UniVent

Universalt ventilationshættesystem for effektiv ventilation og sikker gennembrydning af tagflader

Serien af Universal Ventilationshætter for flade og skrå tagflader består af en række forskellige produkter, der er baseret på én fælles idé om at definere et samlet effektivt og easy-to-mount produktsystem af standard Ø125, Ø160 og Ø200 mm ventilationshætter af høj kvalitet. Hætterne kan anvendes og specificeres som gennemføringsløsning for isolerede og ikke-isolerede ventilationsgennemføringer på tagflader udført med forskellige typer tagdækning: tegl, eternit, tagpap osv.

Ved udførelse eller projektering af ventilationsløsninger vil der derfor kunne vælges én standardhætte ud fra en bred produktserie, uanset om anvendelsen er en installation på et fladt, skråt, koldt eller varmt tag. Herved reduceres tidsforbruget for projektering, og grundlaget for en effektiv og fagteknisk korrekt udført montage sikres.

Produkterne er alle fremstillet af aluminiumskomponenter og leveres med en sortlakeret struktur. De isolerede produktvarianter overholder de brandtekniske krav til isolering jf. DS 428, og med afsæt i DS 428 er der udført brandtekniske prøvninger på de ikke-isolerede produktvarianter, og der er påvist en god brandteknisk modstandsevne over for en standardbrand i op til 60 min. (standard brandkurve jf. DBi ISO 834). De ikke-isolerede produktvarianter leveres med kondenssikring, hvorved risikoen for kondensdannelse fra opfugtet ventilationsluft er kraftigt reduceret.

PROJEKTERING OG ORDREAFGIVELSE

For øget overblik over de forskellige produktvarianter ved ordreafgivelse eller for anvendelse ved projektering er der på side 7-8 i databladet indsat en komplet produktoversigt med karakteristiske produktillustrationer samt skitsering af det pågældende produkts anvendelsesformål.

Produktoversigten indeholder endvidere en oversigt over de forskellige tilbehørsprodukter.

MATERIALER

Ventilationshætte:	Aluminium
Kondenssikring:	Aluminium
Nippelrør:	Galvaniseret stål
Isolering:	Glasuld (kun isolerede enheder)
Tagmembran:	Underpap eller Fast Flash (kun varianter med integreret membran)

INSTALLATION

For nærmere information omkring detailudførelse af installationer kan der tages kontakt direkte til FIXNORDIC.



DIMENSIONER OG TEKNISKE KARAKTERISTIKA FOR PRODUKTVARIANTER TIL TAGPAPDÆKNINGER

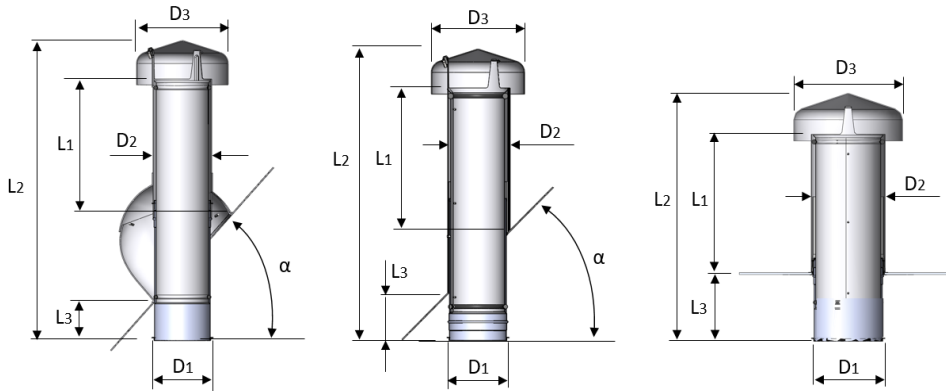

DIMENSIONSOVERSIGT - IKKE-ISOLEREDE VARIANTER

Variant	D1 [mm]	D2 [mm]	D3 [mm]	L1 [mm]	L2 [mm]	L3 [mm]	L4 [mm]	α [°]
Ø125 Fladt tag	DN125*	DN125	Ø200	300	500	130	500	-
Ø125 Skråt tag	DN125*	DN125	Ø200	300	500**	130	430	10 - 48
Ø125 Fast smig	DN125*	DN125	Ø200	300	650**	100	480	10 - 48
Ø160 Fladt tag	DN160*	DN160	Ø250	300	510	130	500	-
Ø160 Skråt tag	DN160*	DN160	Ø250	300	500**	130	465	10 - 48
Ø160 Fast smig	DN160*	DN160	Ø250	300	700**	100	465	10 - 48

* Nippelrørdimension jf. DS/EN 1506

** Denne dimension afhænger af den specifikke taghældning

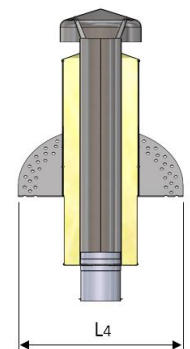
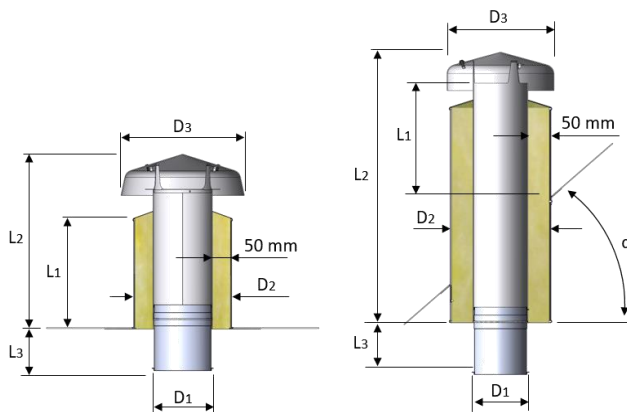

DIMENSIONSOVERSIGT - ISOLEREDE VARIANTER

Variant	D1 [mm]	D2 [mm]	D3 [mm]	L1 [mm]	L2 [mm]	L3 [mm]	L4 [mm]	α [°]
Ø125 Fladt tag	DN125*	Ø236	Ø250	300	455	130	700	-
Ø125 Skråt tag	DN125*	Ø236	Ø250	300	500**	130	506	10 - 48
Ø160 Fladt tag	DN160*	Ø270	Ø320	300	455	130	750	-
Ø160 Skråt tag	DN160*	Ø270	Ø320	300	500**	130	546	10 - 48
Ø200 Fladt tag	DN200*	Ø312	Ø420	300	502	130	800	-
Ø200 Skråt tag	DN200*	Ø312	Ø420	300	500**	130	586	10 - 48

* Nippelrørdimension jf. DS/EN 1506

** Denne dimension afhænger af den specifikke taghældning

DIMENSIONER OG TEKNISKE KARAKTERISTIKA FOR PRODUKTVARIANTER TIL TEGL, ETERNIT OSV.

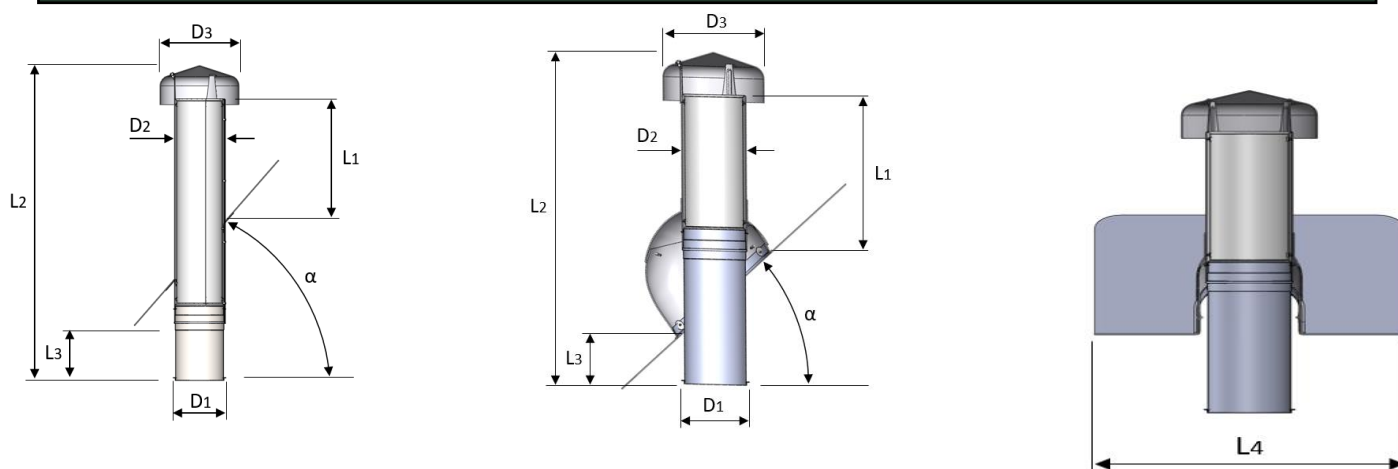

DIMENSIONSOVERSIGT - IKKE-ISLEREDE VARIANTER								
Variant	D1 [mm]	D2 [mm]	D3 [mm]	L1 [mm]	L2 [mm]	L3 [mm]	L4 [mm]	α [°]
Ø125	DN125*	Ø128,25	Ø200	300	645	100**	455	10 - 48
Ø125 Fast smig	DN125*	Ø129	Ø200	300	500**	140	430	10 - 48
Ø160	DN160*	Ø163,3	Ø250	300	630	40**	500	10 - 48
Ø160 Fast smig	DN160*	Ø163,5	Ø250	300	500**	140	465	10 - 48

* Nippelrørdimension jf. DS/EN 1506



DIMENSIONSOVERSIGT - ISLEREDE VARIANTER								
Variant	D1 [mm]	D2 [mm]	D3 [mm]	L1 [mm]	L2 [mm]	L3 [mm]	L4 [mm]	α [°]
Ø125	DN125*	Ø236	Ø250	300	760**	260	540	0 - 48
Ø160	DN160*	Ø270	Ø320	300	800**	260	560	0 - 48
Ø200	DN200*	Ø312	Ø420	300	800**	260	720	0 - 48

* Nippelrørdimension jf. DS/EN 1506
 ** Denne dimension afhænger af den specifikke taghældning

PRODUKTTEKNIK

Diagrammerne herunder angiver de statiske tryktab for den dimensionerende projektering for de to dimensionsvarianter Ø125 og Ø160 mm for henholdsvis indtag og afkast.

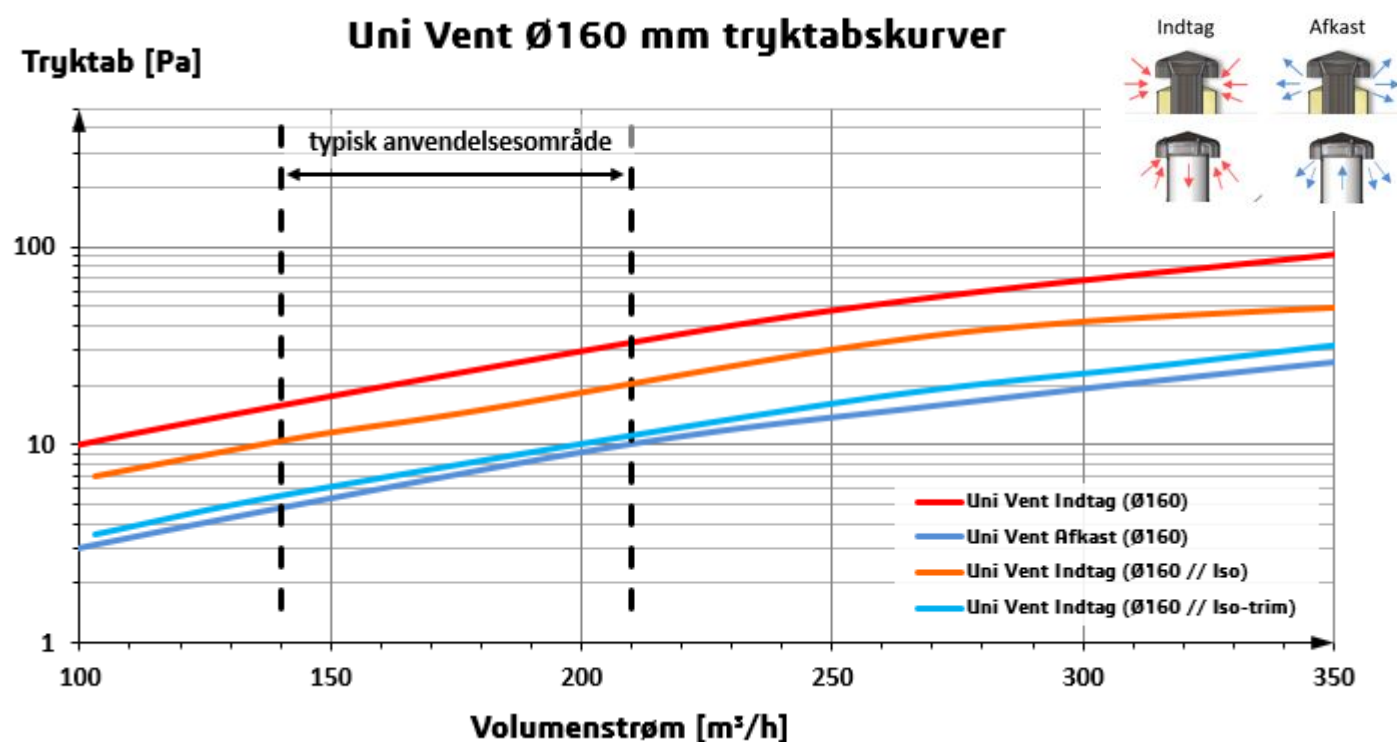
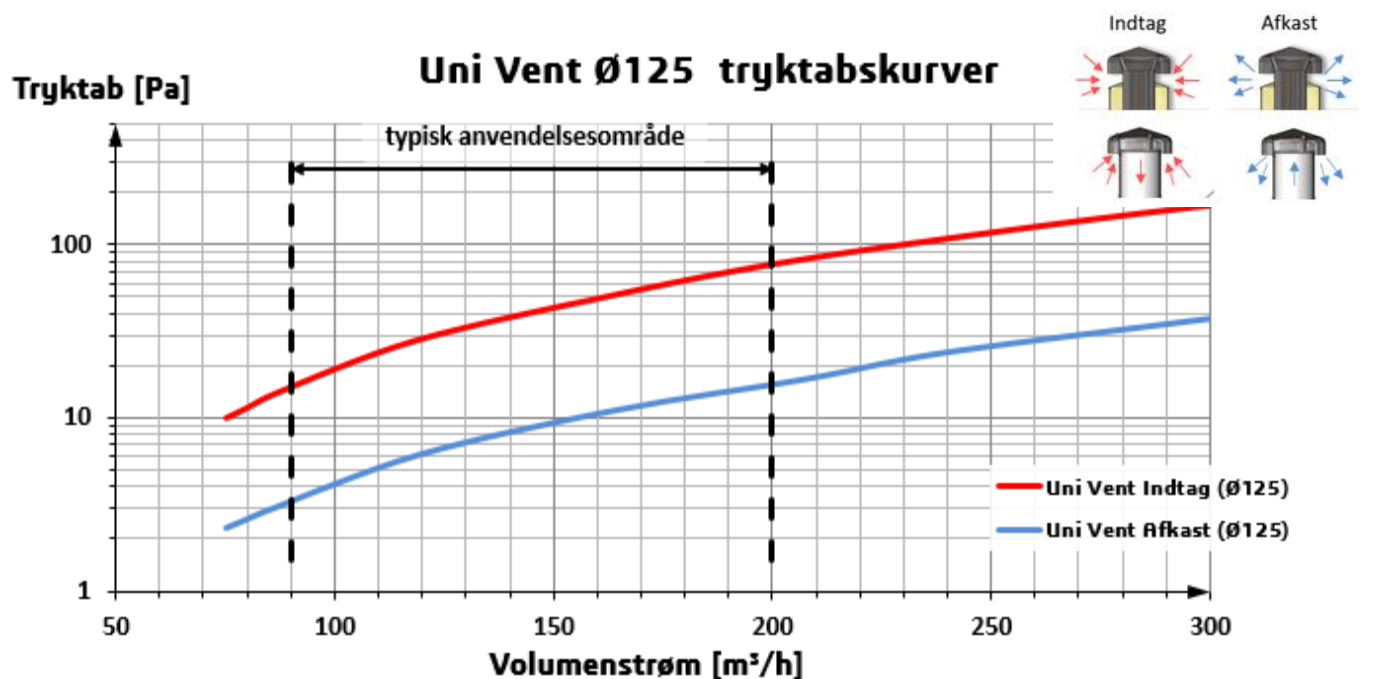





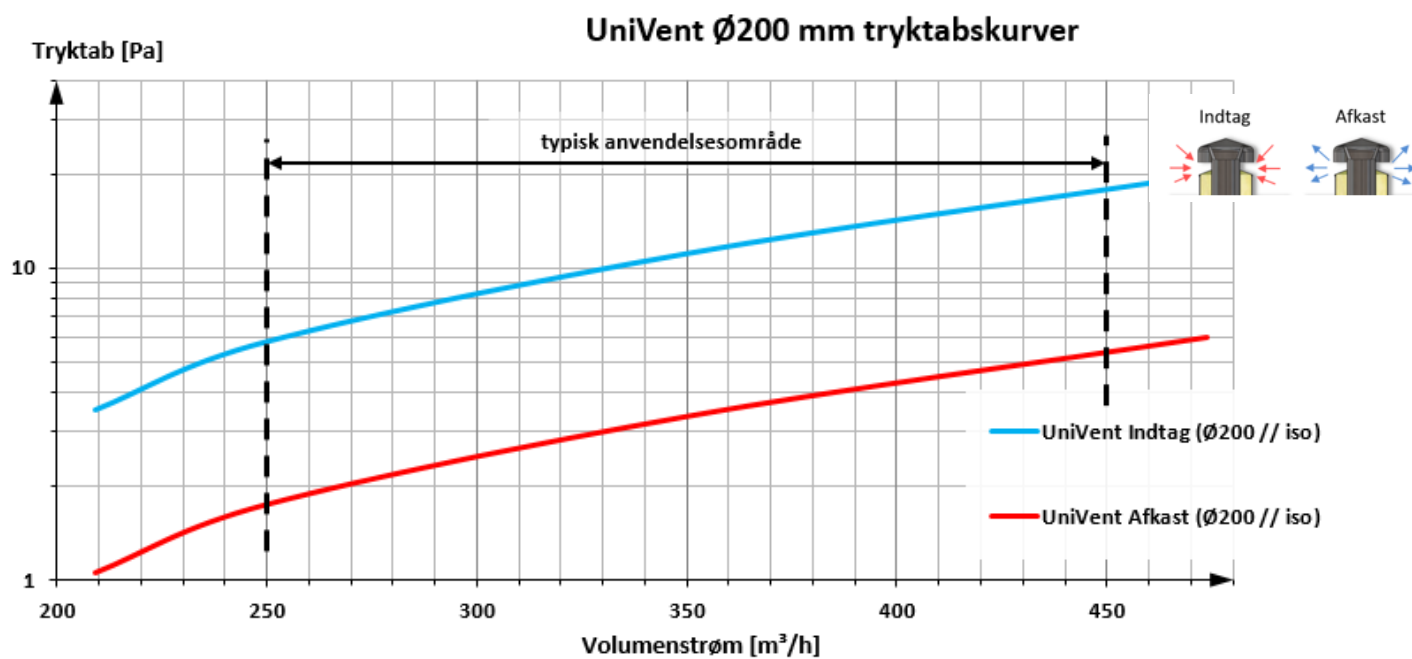



















PRODUKTTEKNIK

Diagrammet herunder angiver de statiske tryktab for den dimensionerende projektering for dimensionsvarianten Ø200 mm for henholdsvis indtag og afkast.



PRODUKTOVERSIGT





UniVent applikationsmatrix				
Standard produktvarianter				
Tagtype	Taghældning	Dimension	Varenumre	Produktillustration
	0° - 7°	Ø125	9112500-101	
		Ø160	9116000-101	
		Ø200	9120000-101	
	0° - 7°	Ø125	91125000-101	
		Ø160	91160000-101	
	0° - 7°	Ø125	9012500-101	
		Ø160	9016000-101	
	0° - 7°	Ø125	90125000-101	
		Ø160	90160000-101	
	10° - 48°	Ø125	9012548-191	
		Ø160	9016048-191	
	10° - 48°	Ø125	9012548-520	
			9012548R-5xx (teglrød)	
			9012599R-5xx (teglrød)	
		Ø160	9016048-520	
			9016048R-5xx (teglrød)	
9016099R-5xx (teglrød)				
Projekt produktvarianter				
Tagtype	Taghældning	Dimension	Varenumre	Produktillustration
	10° - 48°	Ø125	9012599-191	
		Ø160	9016099-191	
	10° - 48°	Ø125	9112599-191	
		Ø160	9116099-191	
		Ø200	9120099-191	
	10° - 48°	Ø125	91125990-191	
		Ø160	91160990-191	
	10° - 48°	Ø125	91125991-191	
		Ø160	91160991-191	
		Ø200	91200991-191	
	10° - 48°	Ø125	911259901-191	
		Ø160	911609901-191	
	10° - 48°	Ø125	9012599-520	
		Ø160	9016099-520	

UniVent produkterne er udviklet af og produceres af FIXNORDIC A/S.





PRODUKTOVERSIGT

UniVent applikationsmatrix

Projekt produktvarianter - fortsat

	10° - 48°	Ø125	9112599-520	
			9112599R-5xx (teglrød)	
		Ø160	9116099-520	
			9116099R-5xx (teglrød)	
		Ø200	9120000-520	
			9120099R-5xx (teglrød)	
	0° - 48°	Ø125	91125600	
			91125900	
		Ø160	91160600	
			91160900	

Membrangennemføringer for dampspærre / undertag

Tagtype	Anvendelse	Dimension	Varenumre	Produktillustration
	Tagpap	Ø100	100101-104	
		Ø125	125101-104	
		Ø160	160101-104	
		Ø200	200101-104	
	Folie- undertag	Ø100	100xxx-xxx	
		Ø125	125xxx-xxx	
		Ø160	160xxx-xxx	
		Ø200	200xxx-xxx	

UniVent produkterne er udviklet af og produceres af FIXNORDIC A/S.